



Collection
SPYRAL

TECHNILAT
FABRIQUÉ EN *Aveyron*



Fabriqué en Aveyron

L'aventure Technilat démarre en 1984.

Jean-Rémy Bergounhe, 20 ans, crée ses premiers sommiers et les vend dans le magasin de literie familial près de Millau dans l'Aveyron.

L'ingéniosité de ses créations associée au soin tout particulier qu'il accorde aux finitions et aux multiples détails de ses sommiers, sont à l'origine d'un succès qui dure depuis et ne se dément pas.

Aujourd'hui, Technilat fabrique en Aveyron des matelas, des sommiers, des têtes de lit haut de gamme, de qualité de conception et de fabrication exemplaire.

Collection Spyril

Sérénité, bien-être, rêve... Ce sont des mots qui nous tiennent à coeur. Et chaque jour, depuis 1984, toutes nos équipes donnent le meilleur d'eux mêmes pour fabriquer des literies et créer un confort idéal.

Et parce que chacun de nos dormeurs est unique, nous réalisons des literies aux confort variés, aux technologies innovantes et aux designs modernes. Notre souhait, trouver votre rêve...

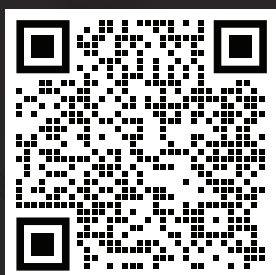

En scannant ce QR code
vous accédez à la version
numérique du catalogue à jour
Tarifs TTC inclus
hors éco-participation

1000 Ressorts & 7 Zones de confort

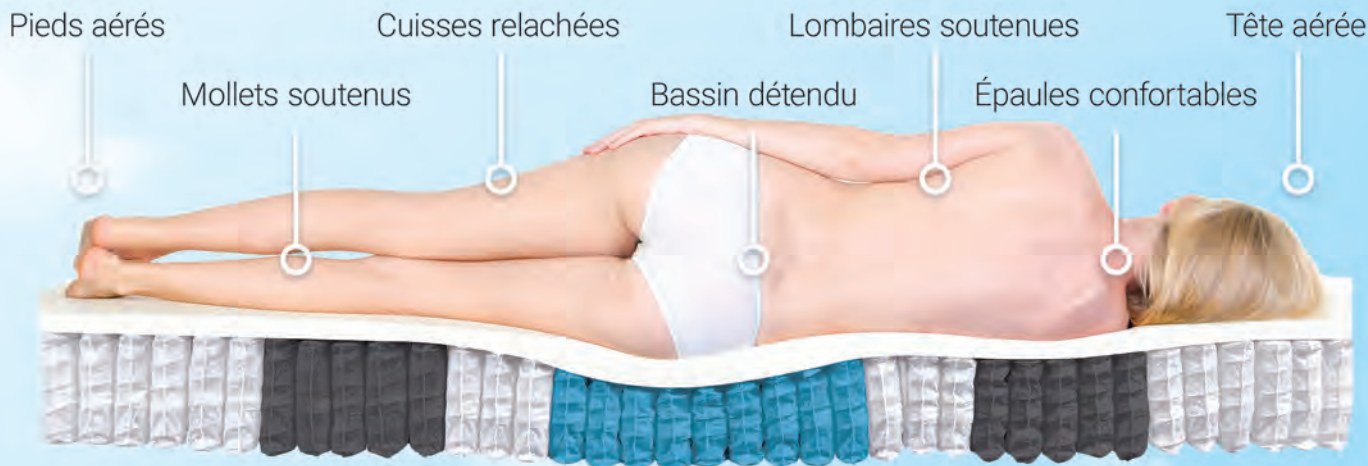

Position idéale

Les disques intervertébraux agissent comme des amortisseurs qui ne peuvent se rétablir que lorsque le dos est parfaitement au repos. Pour cela, il faut lui offrir un soutien uniforme et bien réparti.



Fabriqué
en Aveyron



BELLE LITERIE
EXCELLENCE

7
ans

de Garantie*

*Se reporter au livret de garantie

Des conforts
exceptionnels
un sommeil idéal

Associés aux ressorts ensachés, les matériaux de confort de surface de notre collection Spyril vous apporteront l'aération, l'ergonomie, et le confort dont vous avez toujours rêvé.

Depuis 1984

au service du sommeil



- Chaque ressort a une hauteur de 15 cm. D'une durabilité exceptionnelle, leurs formes légèrement en "tonneau" vous confèrent une nuit silencieuse.
- Les 7 zones de confort des ressorts restent ACTIF à 100 % et s'adaptent point par point à la morphologie de votre corps.
- Ils sont composés de matériaux qui empêchent le développement d'odeurs, de bactéries...Ils vous assurent un renouvellement d'air efficace et un sommeil réparateur.



Visco Thermic

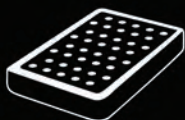

Latex



Haute Résilience



Visco



Micropocket

• Premium •

Fantastique

Hauteur **33 cm** • Accueil **Moelleux** • Soutien **Ferme**



Micropocket



Ressorts ensachés



Latex Pulse

7
ans

de Garantie



BELLE LITERIE
EXCELLENCE



Fabriqué en Aveyron





Coutil • 63% Polyester • 37% Viscose

Ce coutil renforce considérablement la qualité exceptionnelle de confort

Garnissage

Cachemire/Soie 200 g/m² · Ouate 500 g/m²
Extra Souple

Technologie · Ressorts ensachés
Les 7 zones de confort des ressorts ensachés s'adaptent point par point à la morphologie de votre corps

- Dimension 90 x 200 **1000 ressorts**
- Dimension 140 x 190 **1554 ressorts**
- Dimension 160 x 200 **1971 ressorts**
- Dimension 180 x 200 **2283 ressorts**

Âme

- 6 cm **Latex Pulse**
- 4 cm **Micropocket**
- 15 cm **Ressorts ensachés 7 zones**



Dimensions disponibles

Fantastique
Ht = 33 cm

<	80-90	>	<	100	>	<	120-130-140	>	<	160	>	<	180	>	
	190		200		190		200		190		200		190		200

• Premium •

Magnific

Hauteur **33 cm** • Accueil **Enveloppant** • Soutien **Ferme**



Micropocket



Ressorts ensachés



Visco Thermic

7
ans

de Garantie



BELLE LITERIE
EXCELLENCE



Fabriqué en Aveyron





Coutil • 63% Polyester • 37% Viscose

Ce coutil renforce considérablement la qualité exceptionnelle de confort

Garnissage

Cachemire/Soie 200 g/m² · Ouate 500 g/m²
Extra Souple

Technologie · Ressorts ensachés
Les 7 zones de confort des ressorts ensachés s'adaptent point par point à la morphologie de votre corps

Dimension 90 x 200 **1000 ressorts**
Dimension 140 x 190 **1554 ressorts**
Dimension 160 x 200 **1971 ressorts**
Dimension 180 x 200 **2283 ressorts**

Âme

6 cm **Visco Thermic 45 kg/m³**
4 cm **Micropocket**
15 cm **Ressorts ensachés 7 zones**

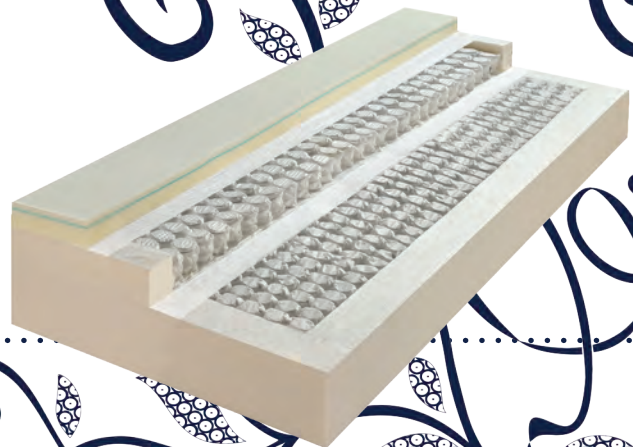

Dimensions disponibles

Magnific
Ht = 33 cm

<	80-90	>	<	100	>	<	120-130-140	>	<	160	>	<	180	>	
	190		200		190		200		190		200		190		200

• Premium •
Unic

Hauteur **33 cm** • Accueil **Tonique** • Soutien **Ferme**



Micropocket



Ressorts ensachés



Haute-résilience

7
ans

de Garantie



BELLE LITERIE
EXCELLENCE



Fabriqué en Aveyron





Coutil • 63% Polyester • 37% Viscose

Ce coutil renforce considérablement la qualité exceptionnelle de confort

Garnissage

Cachemire/Soie 200 g/m² · Ouate 500 g/m²
Extra Souple

Technologie · Ressorts ensachés
Les 7 zones de confort des ressorts ensachés s'adaptent point par point à la morphologie de votre corps

- Dimension 90 x 200 **1000 ressorts**
- Dimension 140 x 190 **1554 ressorts**
- Dimension 160 x 200 **1971 ressorts**
- Dimension 180 x 200 **2283 ressorts**

Âme

- 6 cm **Haute-résilience 35 kg/m³**
- 4 cm **Micropocket**
- 15 cm **Ressorts ensachés 7 zones**



Dimensions disponibles

Unic
Ht = 33 cm

< 80-90 >	< 100 >	< 120-130-140 >	< 160 >	< 180 >
190	200	190	200	190
200	190	200	190	200

COLLECTION SPYRAL

Confort

POETIC

Hauteur **28 cm** · Accueil **Tonique** · Soutien **Ferme**



Ressorts ensachés



Latex Pulse

7
ans

de Garantie



BELLE LITERIE
EXCELLENCE



Fabriqué en Aveyron

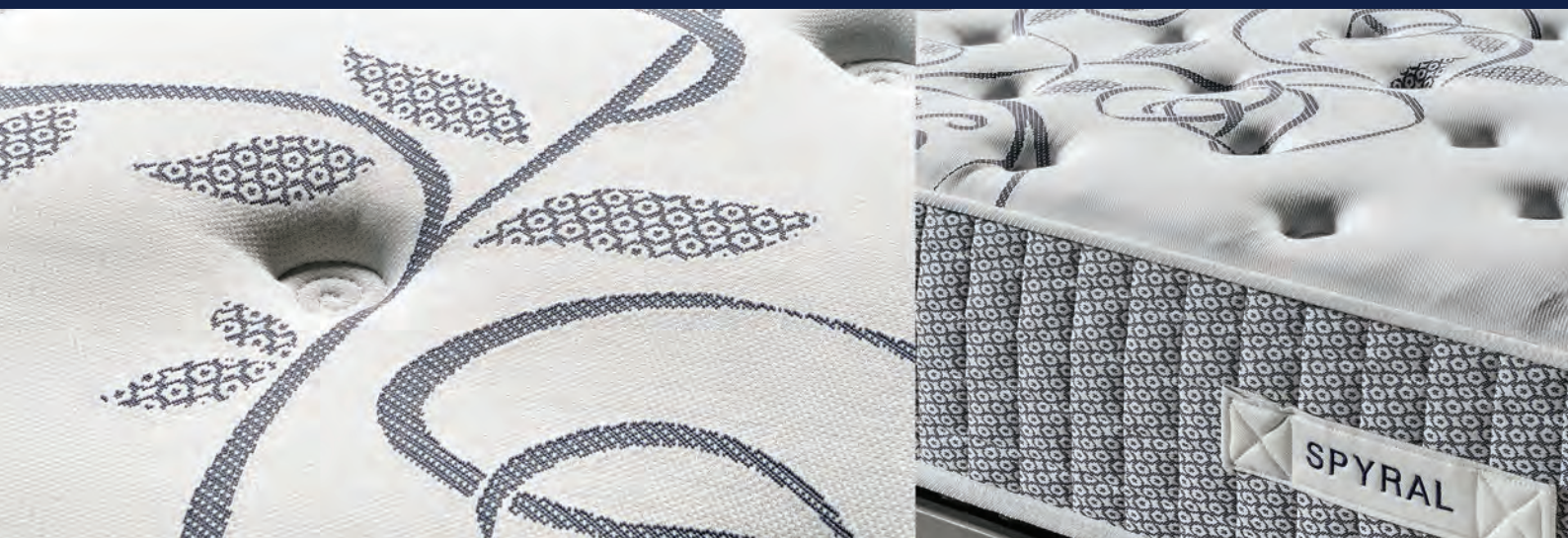

TECHNILAT
FABRIQUÉ EN Aveyron



Coutil • 63% Polyester • 37% Viscose

Ce coutil renforce considérablement la qualité exceptionnelle de confort

Garnissage

Cachemire/Soie 200 g/m² · Ouate 500 g/m²
Extra Souple

Technologie · Ressorts ensachés
Les 7 zones de confort des ressorts ensachés s'adaptent point par point à la morphologie de votre corps

Dimension 90 x 200 **545 ressorts**

Dimension 140 x 190 **828 ressorts**

Dimension 160 x 200 **1061 ressorts**

Dimension 180 x 200 **1233 ressorts**

Âme

6 cm **Latex Pulse**

15 cm **Ressorts ensachés 7 zones**



Dimensions disponibles

Poetic
Ht = 28 cm

< 80-90 >	< 100 >	< 120-130-140 >	< 160 >	< 180 >					
190	200	190	200	190	200	190	200	190	200

COLLECTION SPYRAL

Confort

ARTIC

Hauteur **28 cm** · Accueil **Enveloppant** · Soutien **Ferme**



Ressorts ensachés



Visco Thermic

7
ans

de Garantie



BELLE LITERIE
EXCELLENCE



Fabriqué en Aveyron

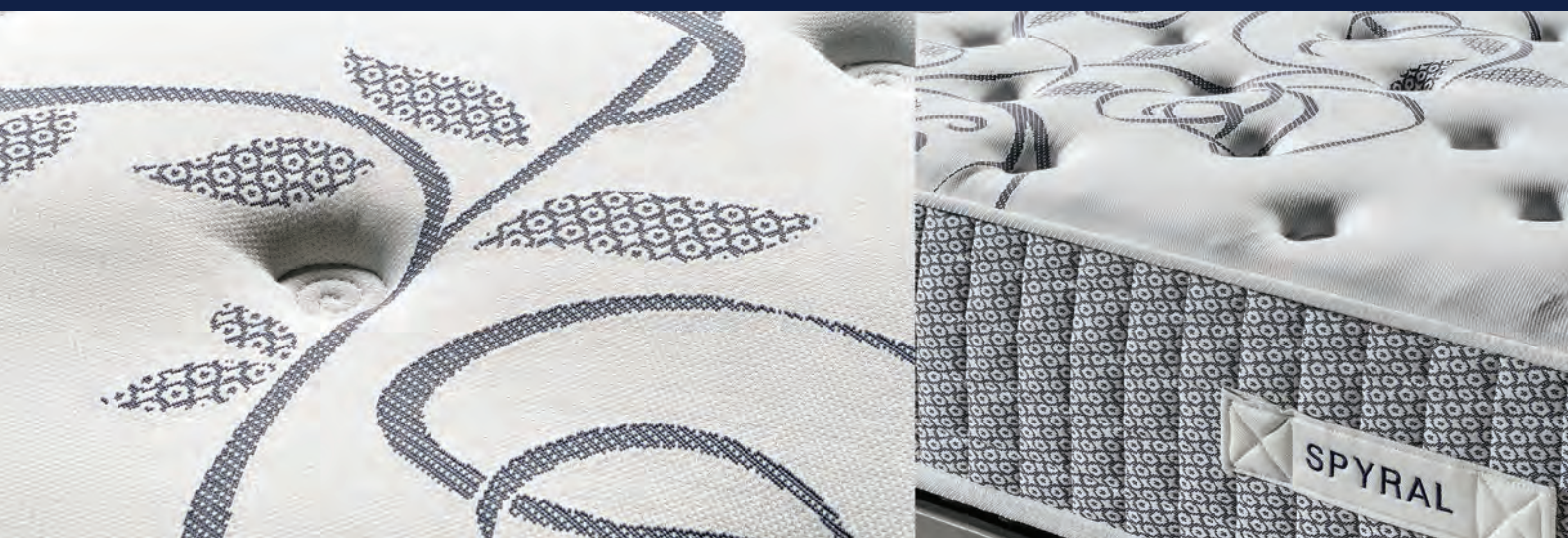

TECHNILAT
FABRIQUÉ EN Aveyron



Coutil • 63% Polyester • 37% Viscose

Ce coutil renforce considérablement la qualité exceptionnelle de confort

Garnissage

Cachemire/Soie 200 g/m² · Ouate 500 g/m²
Extra Souple

Technologie · Ressorts ensachés

Les 7 zones de confort des ressorts ensachés s'adaptent point par point à la morphologie de votre corps

Dimension 90 x 200 **545 ressorts**

Dimension 140 x 190 **828 ressorts**

Dimension 160 x 200 **1061 ressorts**

Dimension 180 x 200 **1233 ressorts**

Âme

6 cm **Visco Thermic 45 kg/m³**
15 cm **Ressorts ensachés 7 zones**

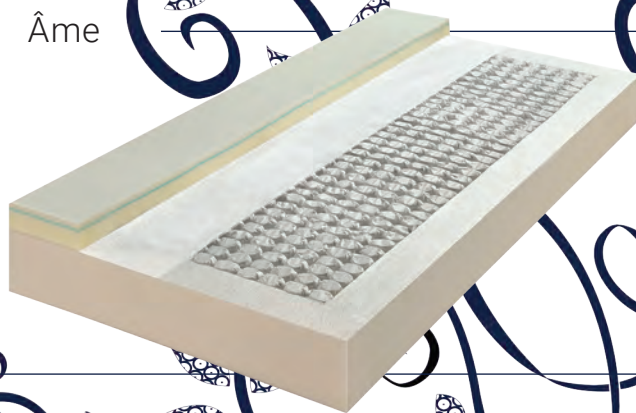

Dimensions disponibles

Artic
Ht = 28 cm

< 80-90 >	< 100 >	< 120-130-140 >	< 160 >	< 180 >
190	200	190	200	190
200	190	200	190	200

COLLECTION SPYRAL

Confort

ESTHÉTIQUE

Hauteur **28 cm** · Accueil **Tonique** · Soutien **Ferme**



Ressorts ensachés



Haute-Résilience

7
ans

de Garantie



BELLE LITERIE
EXCELLENCE



Fabriqué en Aveyron

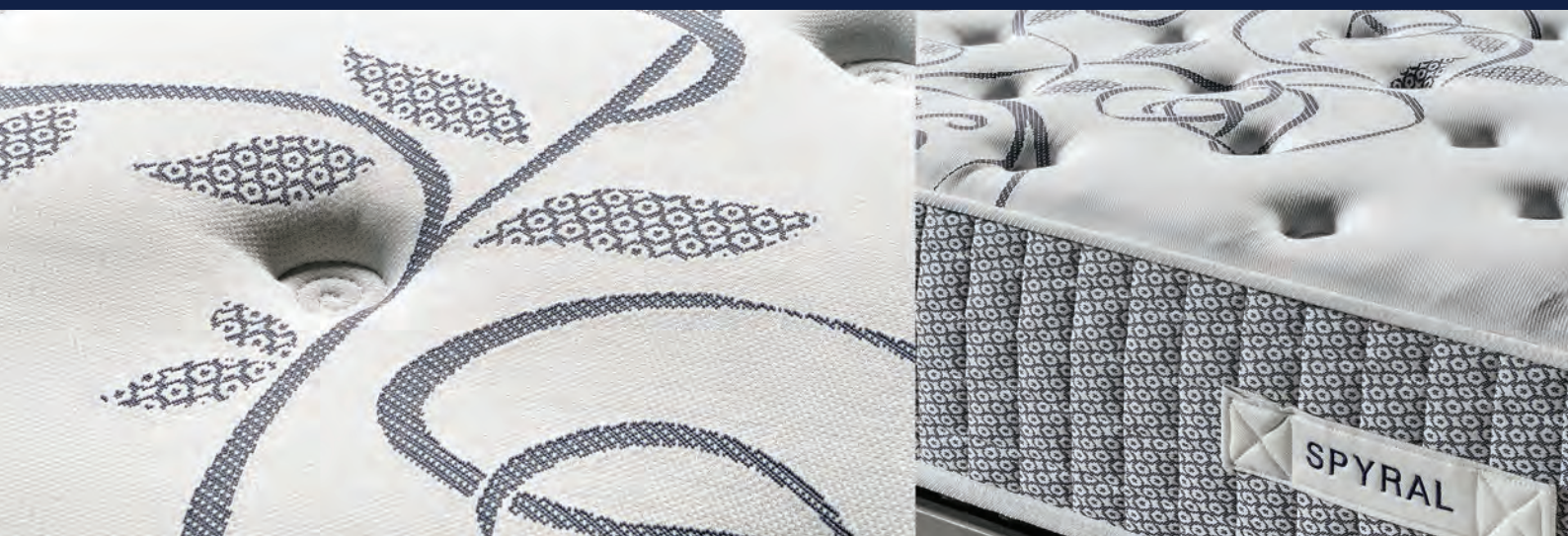

TECHNILAT
FABRIQUÉ EN Aveyron



Coutil • 63% Polyester • 37% Viscose

Ce coutil renforce considérablement la qualité exceptionnelle de confort

Garnissage

Cachemire/Soie 200 g/m² · Ouate 500 g/m²
Extra Souple

Technologie · Ressorts ensachés

Les 7 zones de confort des ressorts ensachés s'adaptent point par point à la morphologie de votre corps

Dimension 90 x 200 **545 ressorts**

Dimension 140 x 190 **828 ressorts**

Dimension 160 x 200 **1061 ressorts**

Dimension 180 x 200 **1233 ressorts**

Âme

6 cm **Haute-Résilience 35 kg/m³**
15 cm **Ressorts ensachés 7 zones**



Dimensions disponibles

Esthétique
Ht = 28 cm

< 80-90 >	< 100 >	< 120-130-140 >	< 160 >	< 180 >					
190	200	190	200	190	200	190	200	190	200

COLLECTION SPYRAL

Essentiel

ONIRIC

Hauteur **25 cm** · Accueil **Tonique** · Soutien **Ferme**



Ressorts ensachés



Latex

5
ans

de Garantie



Fabriqué en Aveyron



TECHNILAT
FABRIQUÉ EN *Aveyron*

FABRIQUÉ EN AVEYRON



Coutil • 63% Polyester • 37% Viscose

Ce coutil renforce considérablement la qualité exceptionnelle de confort

Garnissage

Ouate 500 g/m² • Extra Souple

Technologie • Ressorts ensachés

Les 7 zones de confort des ressorts ensachés s'adaptent point par point à la morphologie de votre corps

Dimension 90 x 200 **545 ressorts**

Dimension 140 x 190 **828 ressorts**

Dimension 160 x 200 **1061 ressorts**

Dimension 180 x 200 **1233 ressorts**

Âme

4 cm **Latex 65 kg/m³**
15 cm **Ressorts ensachés 7 zones**



Dimensions disponibles

Oniric
Ht = 25 cm

< 80-90 >	< 100 >	< 120-130-140 >	< 160 >	< 180 >					
190	200	190	200	190	200	190	200	190	200

TECHNILAT
FABRIQUÉ EN *Aveyron*

COLLECTION SPYRAL

Essentiel
MYSTIC

Hauteur **25 cm** · Accueil **Enveloppant** · Soutien **Ferme**

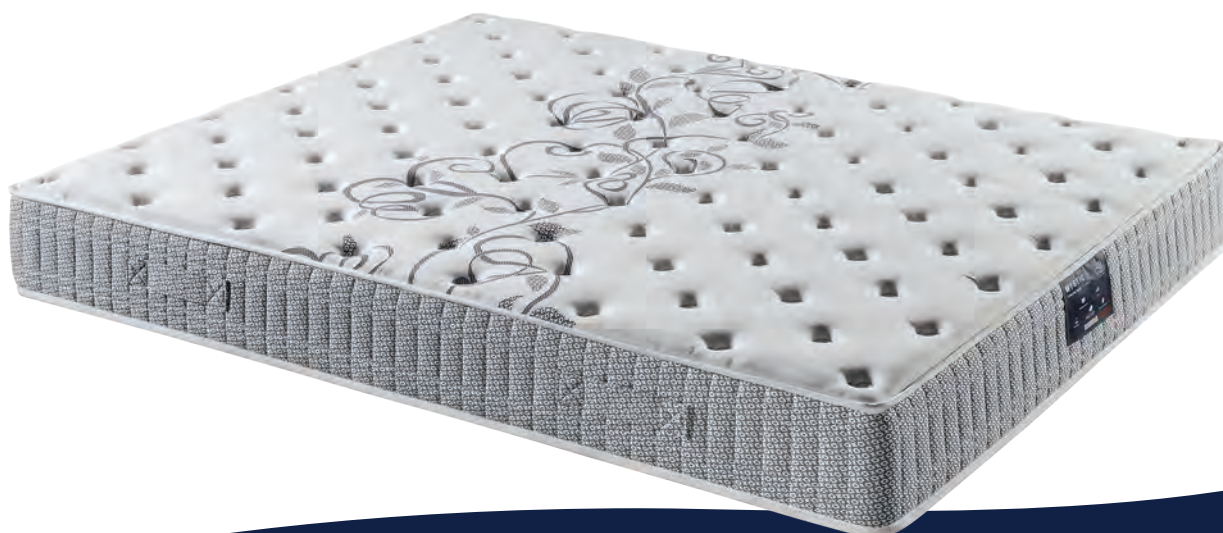

Ressorts ensachés



Visco

7
ans
de Garantie

BELLE LITERIE
EXCELLENCE

Fabriqué en Aveyron



TECHNILAT
FABRIQUÉ EN *Aveyron*

FABRIQUÉ EN AVEYRON



Coutil • 63% Polyester • 37% Viscose

Ce coutil renforce considérablement la qualité exceptionnelle de confort

Garnissage

Ouate 500 g/m² · Extra Souple

Technologie · Ressorts ensachés
Les 7 zones de confort des ressorts ensachés s'adaptent point par point à la morphologie de votre corps

Dimension 90 x 200 **545 ressorts**

Dimension 140 x 190 **828 ressorts**

Dimension 160 x 200 **1061 ressorts**

Dimension 180 x 200 **1233 ressorts**

4 cm **Visco 45 kg/m³**
15 cm **Ressorts ensachés 7 zones**

Âme



Dimensions disponibles

Mystic
Ht = 25 cm

< 80-90 >		< 100 >		< 120-130-140 >		< 160 >		< 180 >	
190	200	190	200	190	200	190	200	190	200



COLLECTION SPYRAL

Essentiel
TONIC

Hauteur **25 cm** · Accueil **Tonique** · Soutien **Ferme**



Ressorts ensachés



Haute-Résilience

5
ans
de Garantie



Fabriqué en Aveyron



TECHNILAT
FABRIQUÉ EN *Aveyron*

FABRIQUÉ EN AVEYRON



Coutil • 63% Polyester • 37% Viscose

Ce coutil renforce considérablement la qualité exceptionnelle de confort

Garnissage

Ouate 500 g/m² · Extra Souple

Technologie · Ressorts ensachés

Les 7 zones de confort des ressorts ensachés s'adaptent point par point à la morphologie de votre corps

Dimension 90 x 200 **545 ressorts**

Dimension 140 x 190 **828 ressorts**

Dimension 160 x 200 **1061 ressorts**

Dimension 180 x 200 **1233 ressorts**

Âme

4 cm **Haute-Résilience 35 kg/m³**
15 cm **Ressorts ensachés 7 zones**



Dimensions disponibles

Tonic
Ht = 25 cm

< 80-90 >		< 100 >		< 120-130-140 >		< 160 >		< 180 >	
190	200	190	200	190	200	190	200	190	200



COLLECTION SPYRAL

Essentiel

ENERGIC

Hauteur **22 cm** · Accueil **Tonique** · Soutien **Ferme**



Ressorts ensachés



Haute-Résilience

5
ans

de Garantie



Fabriqué en Aveyron



TECHNILAT
FABRIQUÉ EN *Aveyron*

FABRIQUÉ EN AVEYRON



Coutil • 63% Polyester • 37% Viscose

Ce coutil renforce considérablement la qualité exceptionnelle de confort

Garnissage

Ouate 300 g/m²

Technologie · Ressorts ensachés

Les 7 zones de confort des ressorts ensachés s'adaptent point par point à la morphologie de votre corps

Dimension 90 x 200 **384 ressorts**

Dimension 140 x 190 **620 ressorts**

Dimension 160 x 200 **736 ressorts**

Dimension 180 x 200 **832 ressorts**

Âme

6 cm **Haute-Résilience 35 kg/m³**

8 cm **Ressorts ensachés 7 zones**

6 cm **Haute-Résilience 35 kg/m³**



Dimensions disponibles

Energic
Ht = 22 cm

< 80-90 >	< 100 >	< 120-130-140 >	< 160 >	< 180 >					
190	200	190	200	190	200	190	200	190	200

TECHNILAT
FABRIQUÉ EN Aveyron

COLLECTION SPYRAL



ÉLECTRIQUE

ERGONOMIC

Hauteur 22 cm · Accueil *Enveloppant* · Soutien *Ferme*



2 faces

pulse

Latex Pulse



Ressorts ensachés



Haute-Résilience

7
ans

de Garantie



BELLE LITERIE
EXCELLENCE



Fabriqué en Aveyron



Existe aussi en versions relevables **Mono, Bi**



TECHNILAT
FABRIQUÉ EN *Aveyron*



Coutil • 63% Polyester • 37% Viscose

Ce coutil renforce considérablement la qualité exceptionnelle de confort

Garnissage

- ❄ Microfibre 300 g/m² · Extra Souple
- ☀ Microfibre 300 g/m² · Extra Souple

Technologie · Ressorts ensachés

Les 7 zones de confort des ressorts ensachés s'adaptent point par point à la morphologie de votre corps

- Dimension 80 x 200 **320 ressorts**
- Dimension 90 x 200 **384 ressorts**
- Dimension 140 x 190 **620 ressorts**
- Dimension 160 x 200 **736 ressorts**
- Dimension 180 x 200 **832 ressorts**

Âme

- 6 cm **Latex Pulse**
- 8 cm **Ressorts ensachés 7 zones**
- 3 cm **Haute-Résilience 35 kg/m³**



Dimensions disponibles

		< 80-90 >		< 100 >		< 120-130-140 >		< 160 >		< 180 >	
		190	200	190	200	190	200	190	200	190	200
Ergonomic Ht = 22 cm	 TPR Mono										
	TPR Duo										
	TPR Bi										

COLLECTION SPYRAL



ÉLECTRIQUE



DÉCLIC

Hauteur 22 cm · Accueil Tonique · Soutien Ferme



2 faces



Visco Thermic



Ressorts ensachés



Haute-Résilience

7
ans

de Garantie



BELLE LITERIE
EXCELLENCE



Fabriqué en Aveyron



Existe aussi en versions relevables **Mono, Bi**



TECHNILAT
FABRIQUÉ EN Aveyron



Coutil • 63% Polyester • 37% Viscose

Ce coutil renforce considérablement la qualité exceptionnelle de confort

Garnissage

- ❄️ Visco 20 mm
- ☀️ Visco 20 mm

Technologie · Ressorts ensachés

Les 7 zones de confort des ressorts ensachés s'adaptent point par point à la morphologie de votre corps

- Dimension 80 x 200 **320 ressorts**
- Dimension 90 x 200 **384 ressorts**
- Dimension 140 x 190 **620 ressorts**
- Dimension 160 x 200 **736 ressorts**
- Dimension 180 x 200 **832 ressorts**

Âme

- 6 cm **Visco Thermic 45 kg/m³**
- 8 cm **Ressorts ensachés 7 zones**
- 4 cm **Haute-Résilience 35 kg/m³**



Dimensions disponibles

		< 80-90 >		< 100 >		< 120-130-140 >		< 160 >		< 180 >	
		190	200	190	200	190	200	190	200	190	200
Déclic Ht = 22 cm	TPR Mono										
	TPR Duo										
	TPR Bi										

COLLECTION SPYRAL



ÉLECTRIQUE



DYNAMIC

Hauteur 22 cm · Accueil Tonique · Soutien Ferme



2 faces



Ressorts ensachés



Haute-Résilience

5
ans

de Garantie



Fabriqué en Aveyron



Existe aussi en versions relevables **Mono, Bi**



TECHNILAT
FABRIQUÉ EN Aveyron



Coutil • 63% Polyester • 37% Viscose

Ce coutil renforce considérablement la qualité exceptionnelle de confort

Garnissage

- ❄ Microfibre 300 g/m² · Extra Souple
- ☀ Microfibre 300 g/m² · Extra Souple

Technologie · Ressorts ensachés

Les 7 zones de confort des ressorts ensachés s'adaptent point par point à la morphologie de votre corps

- Dimension 80 x 200 **320 ressorts**
- Dimension 90 x 200 **384 ressorts**
- Dimension 140 x 190 **620 ressorts**
- Dimension 160 x 200 **736 ressorts**
- Dimension 180 x 200 **832 ressorts**

Âme

- 6 cm **Haute-Résilience 35 kg/m³**
- 8 cm **Ressorts ensachés 7 zones**
- 3 cm **Haute-Résilience 35 kg/m³**



Dimensions disponibles

		< 80-90 >		< 100 >		< 120-130-140 >		< 160 >		< 180 >	
		190	200	190	200	190	200	190	200	190	200
Dynamic Ht = 22 cm	TPR Mono										
	TPR Duo										
	TPR Bi										



NEOLAT V·line

Hauteur version bois : 20 cm

Hauteur version tissu & simili : 18 cm



Finition Bois · Pearl Grey

Pieds · Ori Mat



Chacune des parties a son moteur et sa mécanique indépendante en acier.

Plusieurs traverses en hêtre massif et notamment 2 au centre de la caisse qui **maintiennent les longs pans parfaitement droits.**

2 Traverses métalliques Tête et Pieds qui supportent les efforts : **Aucune déformation possible des moteurs et des pièces mécaniques.**

La motorisation et la mécanique ne dépassent pas sous le cadre du sommier.

Disponible dans **plus de 50 finitions** tissus et bois.

Disponible en version châssis V·line des modèles Combilat et Neolat.

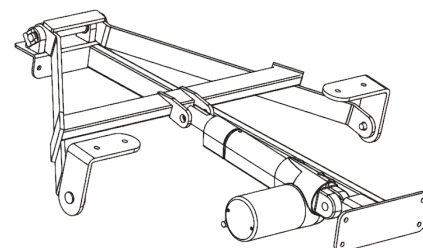
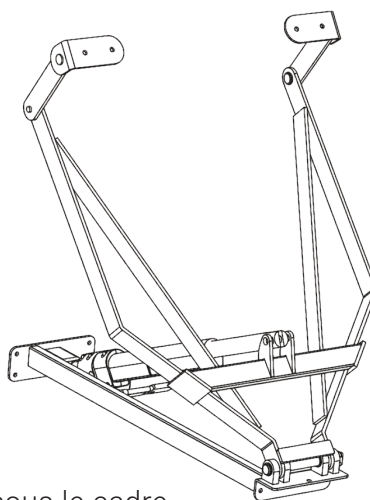

Pour en savoir plus, sur la technologie V·line scannez le qr code

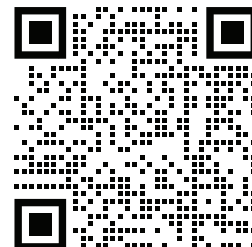

ROTULES

Rotules qui réagissent aux mouvements du corps et maintiennent le matelas.

LATTES

Lattes anti-dérapantes en multiplis de hêtre 7 plis recouvertes d'un film protecteur.

Système bi lattes au niveau du bassin.

Zone épaules assouplie et respirante.

Lattes en fibre de verre en option : elles offrent une grande résistance et une flexibilité parfaite pour ce type de sommier.



STRUCTURE & MOTORISATION

Vérins motorisés puissants et silencieux.

Modèle équipé de 2 moteurs indépendants et renforcés avec remise à zéro.

Puissance Moteur : 4000 Newton

Radio fréquence en option.



Tête translation qui amène un dégagement du bassin particulièrement adaptée en position assise.

Structure et mécanique de relevage renforcées pour une sécurité et une longévité accrue. Barres de renfort pieds pour un usage en toute sécurité quelque soit la position.

Les rotules sont conçues à partir d'un TPE 1er choix, cette matière est choisie pour ses qualités mécaniques : résistance et grande souplesse avec une excellente mémoire élastique, cette matière est recyclable en classe 7.

(TPE est le nom générique de l'élastomère thermoplastique, appelé également caoutchouc thermoplastique).

Dimensions disponibles

Neolat V-line

1 encadrement				2 encadrements					
< 80 >		< 90 >		< 2 x 70 >		< 2 x 80 >		< 2 x 90 >	
190	200	190	200	190	200	190	200	190	200

SOMMIER
FIXE

Concept

Hauteur 18 cm



5
ans

de Garantie



Fabriqué en Aveyron

NOTRE SAVOIR-FAIRE

Depuis 1984, nous fabriquons des literies et notamment des sommiers fixes et relevables dans nos usines situées en Aveyron.

LES AVANTAGES

Sommier à lattes actives
Multiples finitions pour décorer
votre chambre

Matelas encastré dans le sommier
Garantit un soutien du corps optimal

FABRIQUÉ
EN AVEYRON

ENCADREMENT

En sapin latté

LATTES

Lattes actives en multiplis de hêtre 8 plis recouvertes d'un film protecteur.

Résistance et flexibilité de la latte pour plus de confort.

Conçu en 2 x 22 lattes.

AUTRES CARACTÉRISTIQUES

2 positions de fixation possible des pieds, soit affleurant au sommier, soit en retrait.

Le matelas encastré permet de garder votre matelas fixé et de profiter d'une hauteur de literie confortable.



Dimensions disponibles

Concept · ht : 18 cm

1 encadrement				2 encadrements			
< 140 >		< 160 >		< 2 x 80 >		< 2 x 90 >	
190	200	190	200	190	200	190	200

SOMMIER RELEVABLE

Découvrez un aperçu de nos sommiers relevables.

V·line, la technologie de relaxation exclusive de Technilat. Une structure solide conçue pour durer et offrir un confort exceptionnel & au design moderne.

Le détail de nos sommiers est disponible sur le catalogue général Technilat.



Fuerte V·line

Tête à translation



Duoplot V·line

Tête à translation



Combilat V·line

Tête à translation

Disponible en version chassis

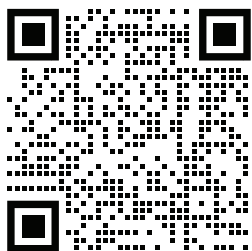

Pour en savoir plus,
sur la technologie V·line
scannez le qr code



V·LINE®

Disponibilité de tous
nos sommiers
relevables avec
la technologie V·line
courant 2023



Garantie Sommier & Moteur

SOMMIER RELEVABLE

Découvrez un aperçu de nos sommiers relevables. Des technologies innovantes, aux confort exceptionnels & au design moderne. Le détail de nos sommiers est disponible sur le catalogue général Technilat.



BoxDéco

Les parties relevables s'intègre à l'encadrement

Tête translation

Existe en versions Mono Jumelage, Bi Jumelage et Duo



Mono BoxDéco

Les parties relevables s'intègre à l'encadrement

Tête translation



Mono Box

Les parties relevables du sommier sont

recouvertes de mousse pour un meilleur confort



Mono Lattes

Tête translation



Mono Plots

Tête translation



V-LINE®

Disponibilité de tous nos sommiers relevables avec la technologie V-line courant 2023



Garantie Sommier & Moteur

SOMMIER FIXE

Découvrez un aperçu de nos sommiers fixes.

Une grande variété de design et un choix multiple de finition.

Le détail de nos sommiers est disponible sur le catalogue général Technilat.



Lit Coffre Evo 2

Espace de rangement

Lattes actives

Hauteur : 38 cm



Deco 10 · 15 · 23

3 Hauteurs au choix

Lattes actives



Vintage

Hauteur sommier = 18 cm

Hauteur têtes de lit ronde et carré= 90 cm

Hauteur pieds de lit ronde et carré= 60 cm

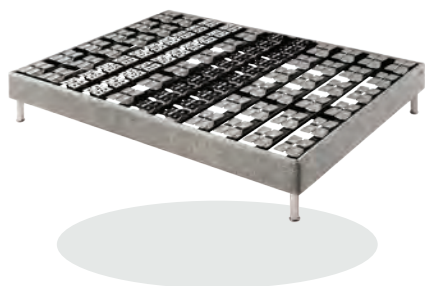

Somplots

Hauteur : 18 cm

Chaque plot s'adapte aux mouvements du corps

ACCESSOIRE TÊTE DE LIT

Une gamme de têtes de lit fabriquées au sein de notre usine
Aveyronnaise
Retrouvez l'ensemble des accessoires sur le catalogue général

5
ans

de Garantie

Boudoir



Triptyc



Panoramique



Bali

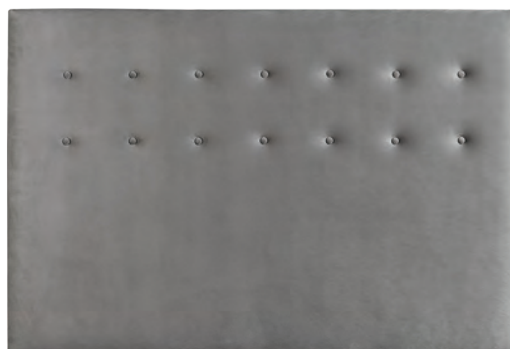

Alaska



Diagonale



Bermudes



Sumatra

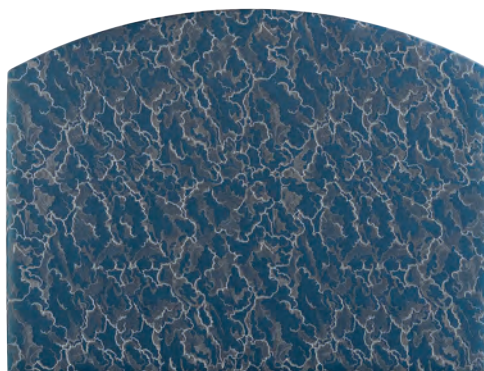

Retrouvez l'ensemble des accessoires sur le catalogue général Technilat

ACCESSOIRE PIED DE LIT

Retrouvez l'ensemble des accessoires
sur le catalogue général Technilat

2
ans

de Garantie



Ori Brillant



Ori Mat

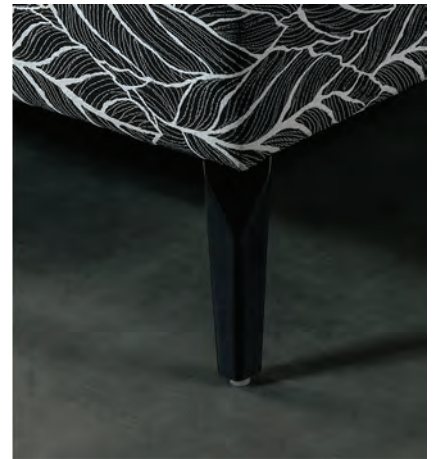

Chêne huilé



Chêne huilé
avec bague inox



Tarso



ST3403



Noyer



Naturel



Chromé



Satiné



Carré 15 cm



Carré 8 cm



Biseaux Noir

SOCLE



Blanc Laqué



Noir Laqué



Noir Mat



Anthracite Laqué

Boudoir · Z10



TECHNILAT
FABRIQUÉ EN *Aveyron*
THEVENON

Maison fondée en 1908
PARIS

La maison Thevenon est une entreprise française, 100% Familiale depuis 4 générations, reconnue dans le domaine du design de tissus. La collaboration avec des designers permet de proposer des tissus modernes et uniques.

Retrouvez l'ensemble de nos finitions sur le catalogue général Technilat.



Z01



Z02

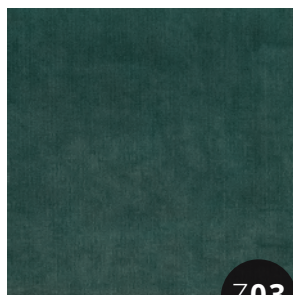

Z03



Z04

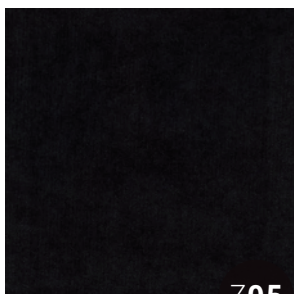

Z05

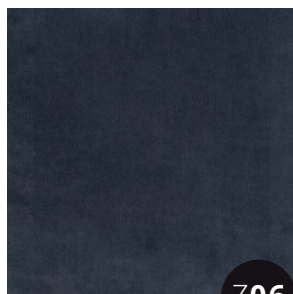

Z06



Couette · Z1 · Z2

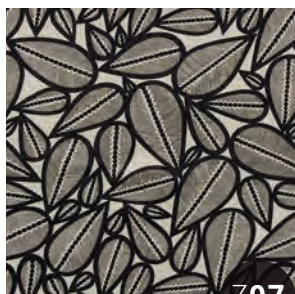

Z07

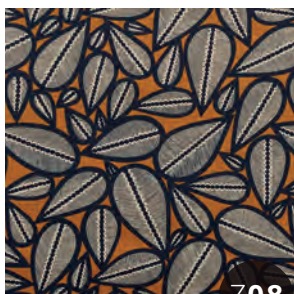

Z08

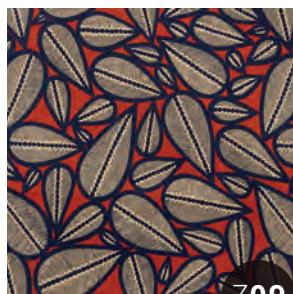

Z09

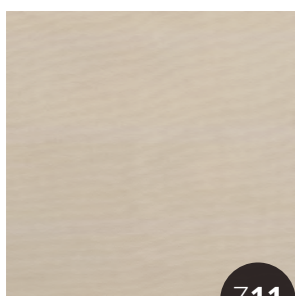

Z11

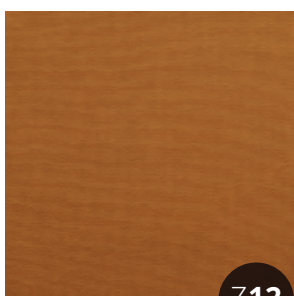

Z12

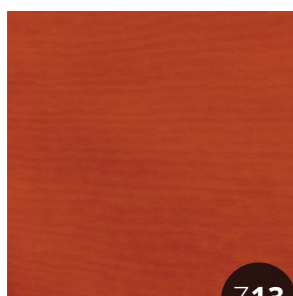

Z13



Z10

Chêne · S01



Pièce d'angle Noir

Frêne Blanc



Pièce d'angle Noir

Pearl Grey



Pièce d'angle Noir

Cappuccino



Pièce d'angle Gris Alu

Chêne Brun



Pièce d'angle Gris Alu

Chêne Gris



Pièce d'angle Gris Alu

Gris Toilé

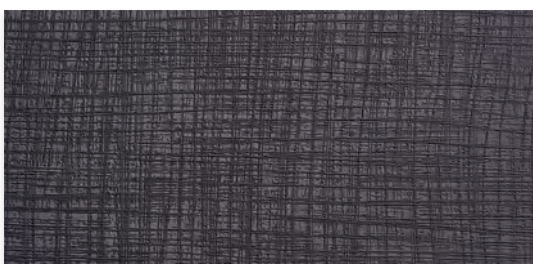

Pièce d'angle Gris Alu

Merisier

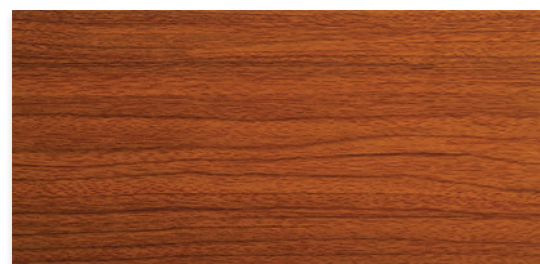

Pièce d'angle Caramel

Vintage Leather

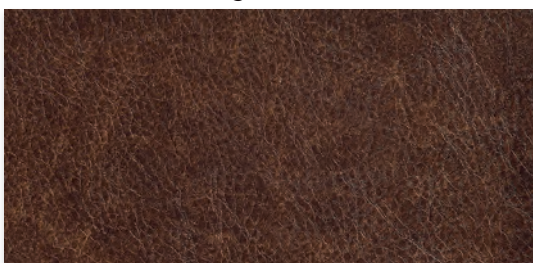

Pièce d'angle Noir

Wengué

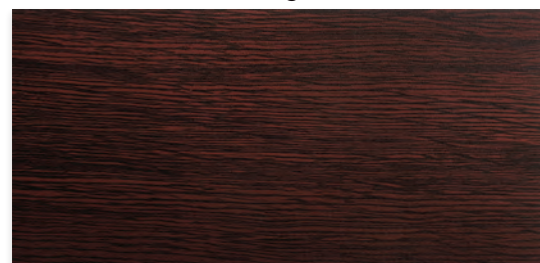

Pièce d'angle Moka



Technilat
Z.A.C. de Naujac · 12450 La primaube
05 65 71 44 41
www.technilat.fr

